

PLANO DE UBICACION Esc: 50

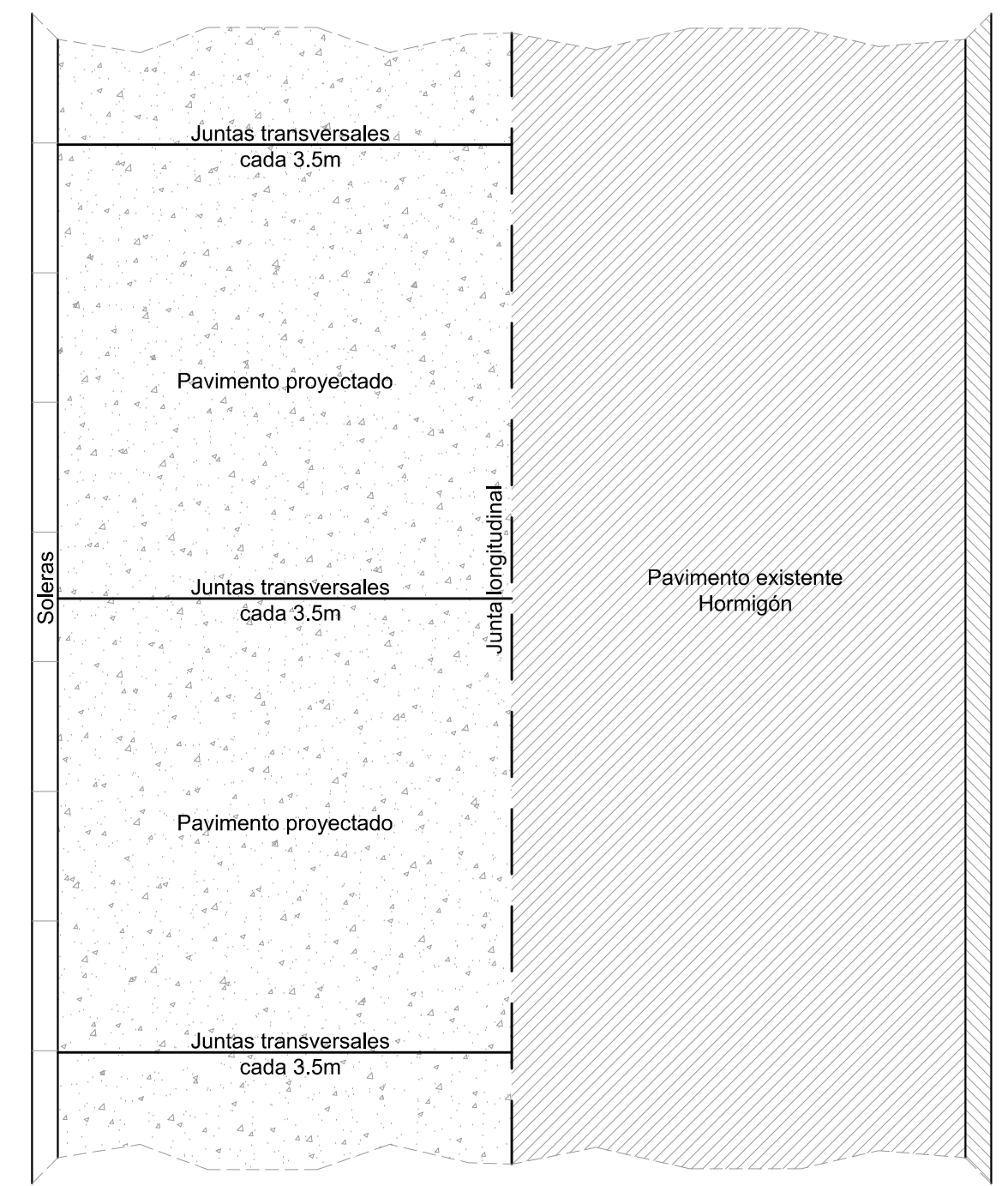

DETALLE DE JUNTAS CALZADA CALLE CARRERA Esc: 1/50

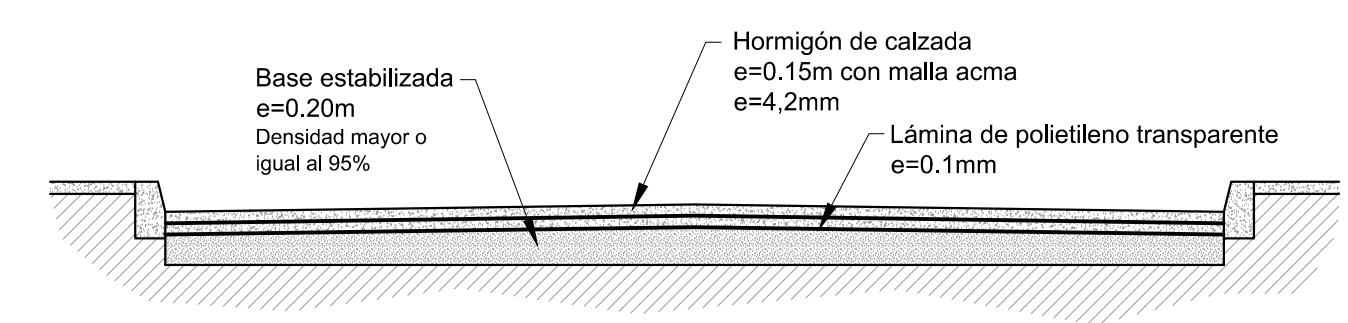

DETALLE CALZADA CALLE CARRERA Esc: 1/50

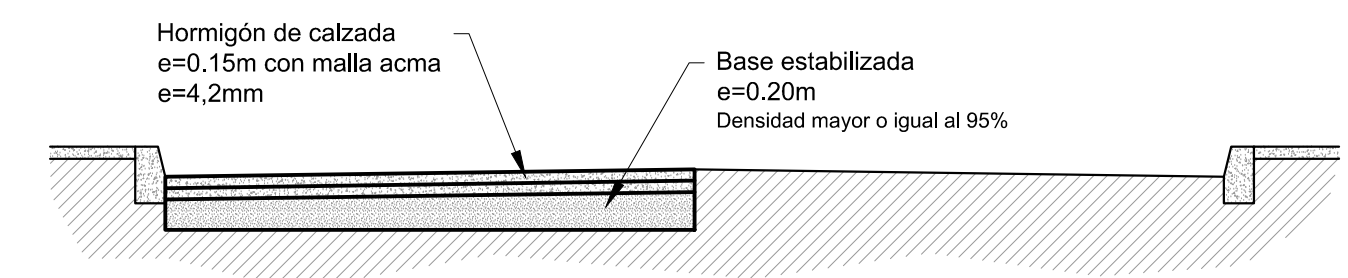

DETALLE CALZADA CALLE CARRERA Esc: 1/50

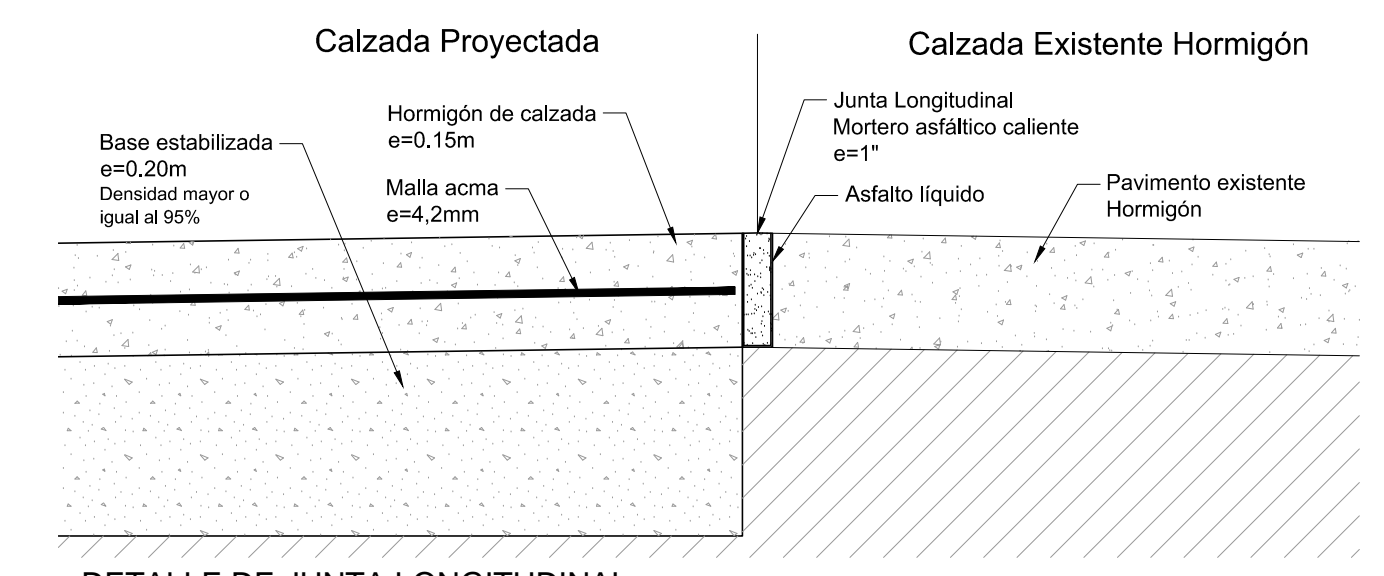

DETALLE DE JUNTA LONGITUDINAL Esc: 1/10

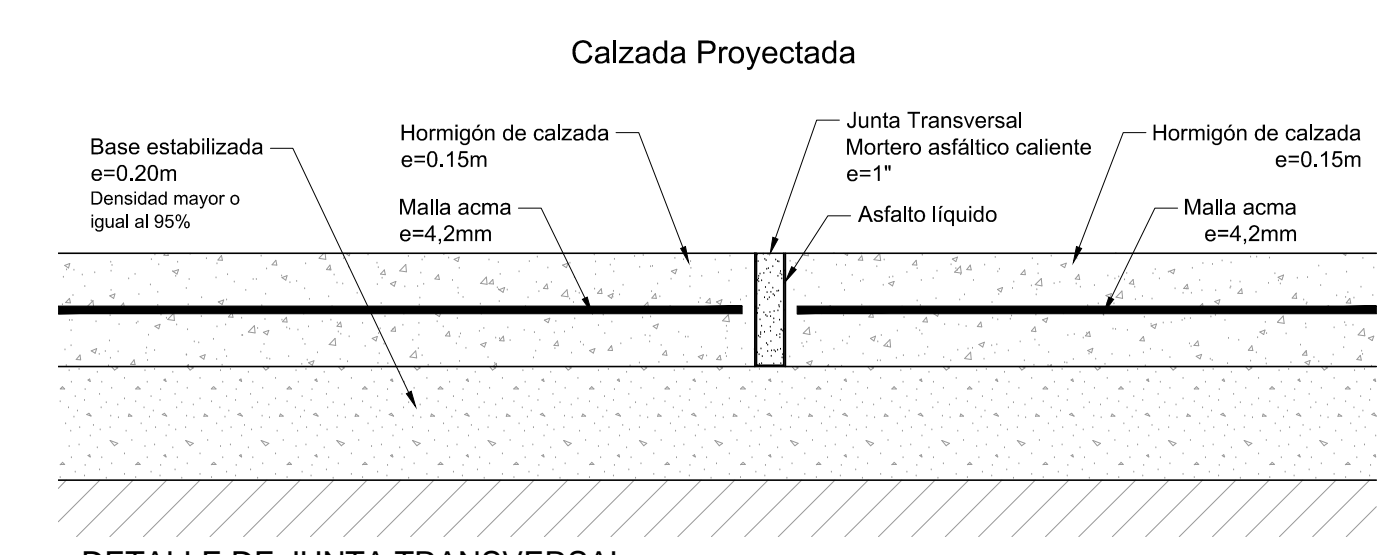





DETALLE DE JUNTA TRANSVERSAL Esc: 1/10

MODIFICACIONES		
N°	FECHA	MATERIA



I. MUNICIPALIDAD DE QUILLOTA
SECRETARIA COMUNAL DE PLANIFICACION

PROYECTO: MEJORAMIENTO BACHES CALLE CARRERA ENTRE CALLE ESMERALDA Y CALLE 18 DE SEPTIEMBRE - COMUNA DE QUILLOTA
PROGRAMA DE MEJORAMIENTO URBANO REGION VALPARAISO

CONTENIDO: PLANTA DE UBICACION DETALLES	DIRECCION: CALLE CARRERA	ROL:
 DR. LUIS RELLA GAJARDO ALCALDE MUNICIPALIDAD DE QUILLOTA	 CECILIA PEÑA M. DIRECTORA SECCION PLANIFICACION URBANA	LAMINA ARG 1/1
 SECRETARIA CECILIA PEÑA M. ARQUITECTO	V/B* DOM	
FECHA: MARZO 2017	ESCALA: DADAS	